



CMC/ CPP/ CMB SERIES

Power & signal connectors
with screw locking system

Contents

Implementation Synoptic	4-5
Synoptic.....	6
Technical Characteristics.....	7

CMC Connectors

Synoptic.....	8
Part Numbering System	9
Configurations.....	10-11
Crimp Contacts.....	12-13

CPP Connectors

Synoptic.....	14
Part Numbering System	15
Configurations.....	16-17
Crimp Contacts.....	18-19

CMB Connectors

Characteristics & Synoptic	20
Part Numbering System	21

Backshells, Accessories & Tools

Backshells (cable indexes).....	22-23
Accessories.....	24-25
Dimensions	26-27
Panel Cut Out & Weights	28
Crimping tools.....	29

MAIN CHARACTERISTICS

CMC / CPP / CMB

- In accordance with standard NF F 61-030
- In accordance with the RoHS directive
- In accordance with fire & smoke requirements
- Screw Locking
- Removable contacts retained by spring clip
- Interchangeable inserts



CMC Series

- Signal Connector
- Housing: Aluminium
- Salt Spray: 96 hours or 500 hours
- Durability: 500 mating cycles



CPP Series

- Power Connector
- Housing: Aluminium
- Salt Spray: 96 hours or 500 hours
- Durability: 500 mating cycles



CMB Series

- Power or Signal Connector
- Housing: Bronze
- Salt Spray: > 500 hours
- Durability: > 500 mating cycles

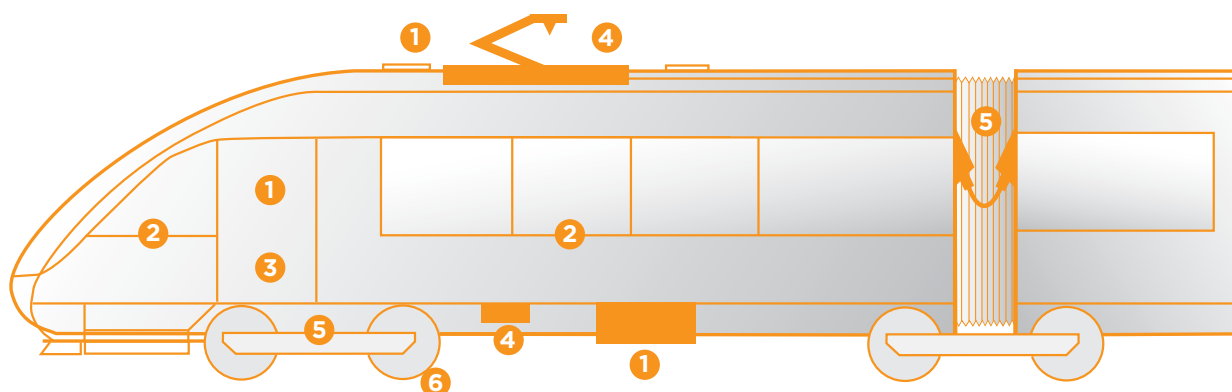

1 Closed Electrical operating area	Requirements	Connectors types recommended
Indoor vehicle cubicle (weather protected)	Salt Spray: 96H	CMC / CPP standard
	Bayonet Coupling	SRC*
Outdoor vehicle cubicle (weather protected) either under frame or upper-roof	Salt Spray: 96H	CMC / CPP standard
	Bayonet Coupling	SRC*
2 Cabin		
Passenger vehicle compartment and driver cabin	Salt Spray: 96H	CMC / CPP standard
	Bayonet Coupling	SRC*
3 Closed electrical operating area ; forced filtered ventilation with outside air		
Machinery compartment	Following technical specifications	CMC

* Other TE Railway connectors from DEUTSCH



SRC series - Signal Connectors

4 Outdoor static applications	Requirements	Connectors types recommended
Under car body, roof (non weather protected locations)	Salt Spray: 96 / 500H	CMC / CPP with Black Varnish
	Bayonet Coupling	SRC*
	Harsh Environment	CMB

5 Outdoor dynamic applications	Requirements	Connectors types recommended
Intercar Train Lines	Salt Spray: 96 / 500H Coupling: < 500	CMC / CPP with Black Varnish
	Salt Spray: > 500H > 500 coupling	CMB
Bogies	Salt Spray: 96 / 500H	CMC / CPP
	Harsh Environment	CMB

6 Outdoor highly dynamic applications	Requirements	Connectors types recommended
Axles	Harsh Environment	CMB

PLUG WITH ENVIRONMENTAL STRAIGHT BACKSHELL

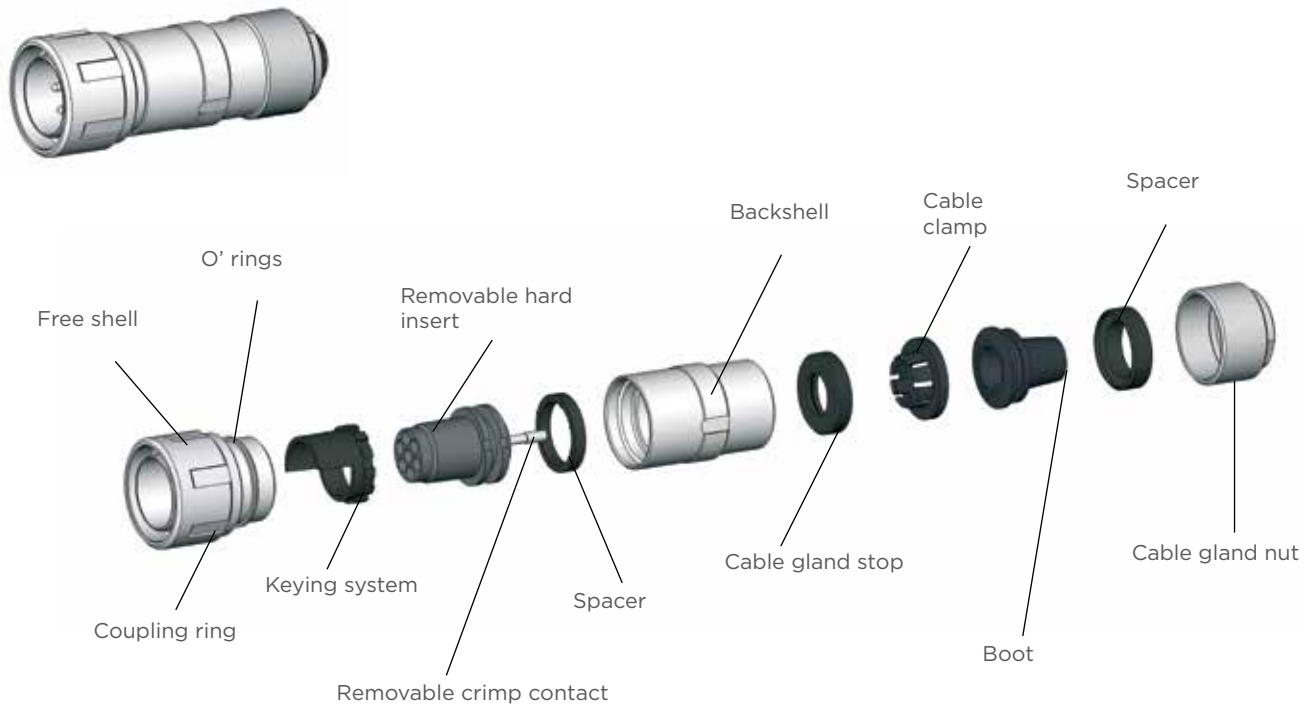

SEMI-RECESSED RECEPTACLE WITH BACK NUT

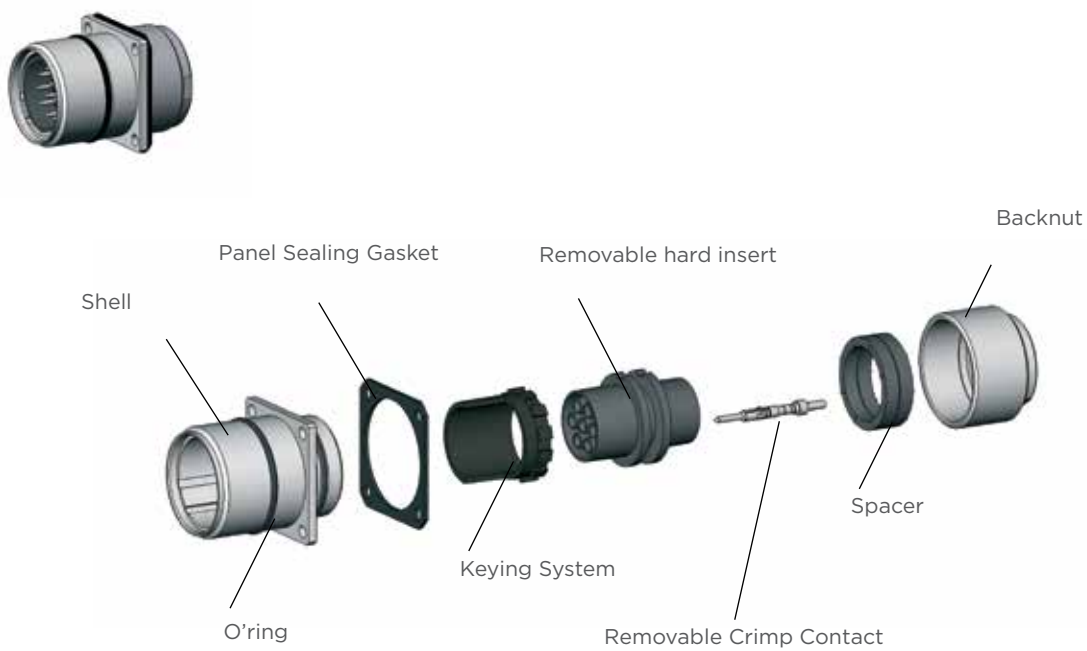

Technical Characteristics

CMC/ CPP

ELECTRICAL

Withstand Voltage : see pages 10 & 11

Creepage & Clearance distance : see pages 10 & 11

Insulation Resistance : > 5000 MΩ

Termination : Crimp Contact

Max. Rating and contact resistance for maximum cross-section:

Caliber	Continuous Service Current	Cable Cross-section	Contact Resistance
Ø 1.6 mm	15 A	1.5 mm ²	< 2.5 mΩ
Ø 2 mm	20 A	2.5 mm ²	< 1.5 mΩ
Ø 3 mm	35 A	6 mm ²	< 1.1 mΩ
Ø 5 mm	50 A	16 mm ²	< 0.6 mΩ
Ø 6 mm	80 A	25 mm ²	< 0.5 mΩ
Ø 7 mm	150 A	50 mm ²	< 0.5 mΩ
Ø 7.9 mm	210 A	70 mm ²	< 0.35 mΩ
Ø 12 mm	260 A	95 mm ²	< 0.2 mΩ
Ø 16 mm	450 A	150 mm ²	< 0.15 mΩ

MATERIALS

Shell : Aluminium Alloy

Shell Finish :

Chemical Conversion : 96 H salt spray

Black Varnish - 500 H salt spray

Crimp Contacts : Silver or gold plated brass

Insulators : Thermoplastic Requirement 2 according to NF F 16-101 & 102 / EN 45545-2

Insert CTI : 400 V < CTI < 600 V according to CEI 60112

CHARACTERISTICS

Service Temperature : -40°C +100°C

Salt Spray : 96 or 500 hours depending on the Finish

Protection Index : IP66 according to EN60529

MECHANICAL

Mating Cycles : 500

Vibrations : 7.9 g (EN 61373:2000)

Shocks : 30 g - 30ms (EN 61373:2000)

Keyings :

12 positions for sizes 02, 04, 07, 19, 27

14 positions for size 61

RECEPTACLE



32

Square Receptacle



33

Square receptacle with shielding

The panel sealing gasket is supplied with the receptacle

Backshell for RECEPTACLES



EA

Backnut



RD

Environmental Straight Backshell



M

Backshell with ISO thread



PG

Backshell with PG thread

PLUG



36

Plug



38

Plug with shielding

Backshell for PLUGS



RD

Environmental Straight Backshell



M

Backshell with ISO thread



PG

Backshell with PG thread

SHELL TYPES

- 32** Square Receptacle
 - 36** Plug
 - 33** Square Receptacle (shielding)
 - 38** Plug (shielding)
- } except size 02 & 61

BACKSHELL TYPES

- EA** Backnut
- M** Backshell with ISO Thread
- PG** Backshell with PG Thread
- RD** Environmental straight Backshell

SHELL SIZE

02 - 04 - 07 - 19 - 27 - 61

CONFIGURATIONS

See pages 10-11

Defined by the number of cavities in the insert

CONTACT TYPES

- P** Male
- S** Female

KEYING SYSTEMS

See the instruction Notice N° FT08010

Sizes 02 - 04 - 07 - 19 - 27 : N, 1, 2, 3, 4, 5, 6, 7, 8, 9, X, Y

Size 61 : N, 1, 2, 3, 4, 5, 6, 7, 8, 9, A, B, C, D

CABLE INDEXES

See pages 22-23

See accepted cable characteristics

OPTIONS

- No digit** 96 H Salt Spray : standard contacts included
- 090** 96 H Salt Spray : without contact
(to be ordered separately) (pages 12-13)
- A01** 500 H Salt Spray / Black Varnish : standard contacts included
- A91** 500 H Salt Spray / Black Varnish : without contacts
(to be ordered separately) (pages 12-13)

SIZE 02

04 4 contacts Ø 1.6 mm
1 forward contact



	Service Voltage	Withstand Voltage
NF F 61-030	220 V	> 2550 V eff.

* Creepage Dist. : 9 mm - Clearance Dist. : 4.10 mm

SIZE 04

04 4 contacts Ø 2 mm
1 forward contact



	Service Voltage	Withstand Voltage
NF F 61-030	400 V eff.	> 3250 V eff.

* Creepage Dist. : 12 mm - Clearance Dist. : 4.3 mm

SIZE 07

05 5 contacts Ø 3 mm
1 forward contact

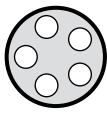

	Service Voltage	Withstand Voltage
NF F 61-030	400 V eff.	> 3250 V eff.

* Creepage Dist. : 12 mm - Clearance Dist. : 4.7 mm

07 7 contacts Ø 1.6 mm
1 forward contact



	Service Voltage	Withstand Voltage
NF F 61-030	220 V	> 2550 V eff.

* Creepage Dist. : 9 mm - Clearance Dist. : 4.10 mm

07 7 contacts Ø 2 mm
1 forward contact

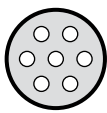

	Service Voltage	Withstand Voltage
NF F 61-030	400 V eff.	> 3250 V eff.

* Creepage Dist. : 12 mm - Clearance Dist. : 4.3 mm

13 13 contacts Ø 1.6 mm
1 forward contact

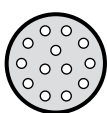

	Service Voltage	Withstand Voltage
NF F 61-030	220 V	> 2550 V eff.

* Creepage Dist. : 9 mm - Clearance Dist. : 4.1 mm

MAX. DIAMETER OF CONDUCTORS IN THE REAR INSERT

Insert Configuration Arrangement		Ø max. in cavity
02	04	4 x 3.9 mm
04	04	4 x 5.5 mm
04	07	7 x 3.93 mm
07	05	5 x 6.4 mm
07	07	7 x 5.5 mm
07	13	13 x 3.93 mm
19	09	9 x 4.2 mm
19	12	12 x 6.4 mm
19	13	13 x 5.5 mm
19	19	19 x 5.5 mm
19	28	28 x 3.93 mm
27	02	2 x 16.3 mm
27	06	2 x 16.3 mm + 4 x 8.6 mm
27	08	2 x 14.4 mm + 4 x 13.5 mm + 2 x 5 mm
27	19	19 x 6.4 mm
27	27	27 x 5.8 mm
27	49	49 x 3.91 mm
61	06	4 x 21.7 mm + 2 x 7.4 mm
61	37	37 x 7.5 mm
61	41	6 x 6.1 mm + 33 x 6 mm + 1 x 16 mm
61	45	2 x 20 mm + 43 x 5.8 mm
61	61	61 x 5.5 mm

*Creepage Distance / Clearance Distance (unmated connector)
For the cavities numbering, ask for the data sheet N° FT 08009

41*

*Contacts have to be ordered separately. Use code 090 in the part number to indicate this. See pages 12-13.

45*

SIZE 19

09 9 contacts Ø 3 mm

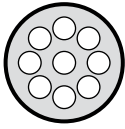

	Service Voltage	Withstand Voltage
NF F 61-030	400 V eff.	> 3250 V eff.

* Creepage Dist. : 12 mm - Clearance Dist. : 4.7 mm

12 12 contacts Ø 3 mm
1 forward contact

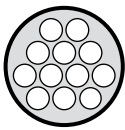

	Service Voltage	Withstand Voltage
NF F 61-030	400 V eff.	> 3250 V eff.

* Creepage Dist. : 12 mm - Clearance Dist. : 4.7 mm

19 19 contacts Ø 2 mm



	Service Voltage	Withstand Voltage
NF F 61-030	400 V eff.	> 3250 V eff.

* Creepage Dist. : 12 mm - Clearance Dist. : 4.3 mm

28 28 contacts Ø 1.6 mm
1 forward contact

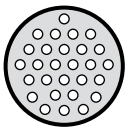

	Service Voltage	Withstand Voltage
NF F 61-030	220 V	> 2550 V eff.

* Creepage Dist. : 12 mm - Clearance Dist. : 4.1 mm

SIZE 27

02 2 contacts Ø 7.9

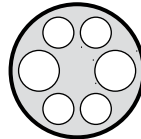

	Service Voltage	Withstand Voltage
NF F 61-030	400 V eff.	> 3250 V eff.

* Creepage Dist. : 12 mm - Clearance Dist. : 8 mm

06 4 contacts Ø 5 mm +
2 contacts Ø 7.9 mm

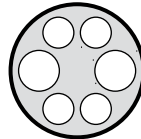

	Service Voltage	Withstand Voltage
NF F 61-030	400 V eff.	> 3250 V eff.

* Creepage Dist. : 12 mm - Clearance Dist. : 8 mm

08 2 + 4 contacts Ø 7mm
+ 2 contacts Ø 3^B mm

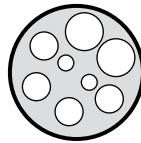

	Service Voltage	Withstand Voltage
NF F 61-030	400 V eff.	> 3250 V eff.

* Creepage Dist. : 12 mm - Clearance Dist. : 8 mm

27 27 contacts Ø 2 mm

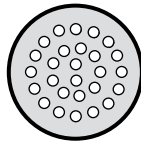

	Service Voltage	Withstand Voltage
NF F 61-030	400 V	> 3250 V eff.

* Creepage Dist. : 12 mm - Clearance Dist. : 4.3 mm

49 49 contacts Ø 1.6 mm

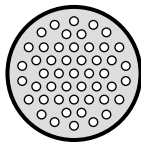

	Service Voltage	Withstand Voltage
NF F 61-030	220 V	> 2550 V eff.

* Creepage Dist. : 9 mm - Clearance Dist. : 4.1 mm

SIZE 61

06 4 contacts Ø 12 mm
+ 2 contacts Ø 3 mm

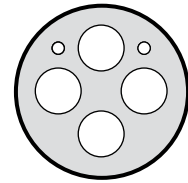

	Service Voltage	Withstand Voltage
NF F 61-030	400 V eff.	> 3250 V eff.

* Creepage Dist. : 19 mm - Clearance Dist. : 11.5 mm

37 37 contacts Ø 3^A mm

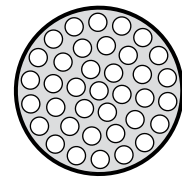

	Service Voltage	Withstand Voltage
NF F 61-030	400 V eff.	> 3250 V eff.

* Creepage Dist. : 12 mm - Clearance Dist. : 6 mm

41* 34 contacts Ø 2 mm +
6 FO + 1 Quadrax

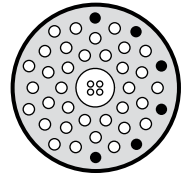

	Service Voltage	Withstand Voltage
NF F 61-030	400 V eff.	> 3250 V eff.

* Creepage Dist. : 12 mm - Clearance Dist. : 4.3 mm

45* 43 contacts Ø 2 mm +
2 coax or twinax

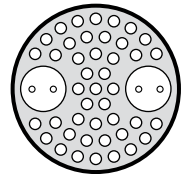

	Service Voltage	Withstand Voltage
NF F 61-030	400 V eff.	> 3250 V eff.

* Creepage Dist. : 12 mm - Clearance Dist. : 4.3 mm

61 61 contacts Ø 2 mm

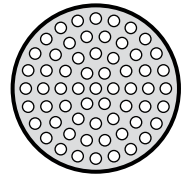

	Service Voltage	Withstand Voltage
NF F 61-030	400 V eff.	> 3250 V eff.

* Creepage Dist. : 12 mm - Clearance Dist. : 4.3 mm

Male Crimp Contacts

CMC

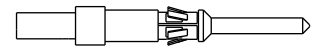

Caliber (mm)		Part Number	Cable section	Obturator	Crimping Tool	Locator	Insertion Tool	Extracting Tool
Ø1.6	Ag	DMCS24150-000B3	0.5 to 1.82 mm ² (AWG 20 to 15)	SRC202730-A00	FT8	TP1012	OUT31748-000A2	OUTEXT0321
	Au	DLNS24150-0003	0.5 to 1.82 mm ² (AWG 20 to 15)	SRC202730-A00	FT8	TP1012	OUT31748-000A2	OUTEXT0321
Ø2	Ag	DMCS1545-0008-B	0.22 to 0.93 mm ² (AWG 24 to 18)	STD0391-0104A3	FT8	TP900-1	OUTS1545-0002	OUTEXT-0370
	Au	DMCS1545-0008-D	0.22 to 0.93 mm ² (AWG 24 to 18)	STD0391-0104A3	FT8	TP900-1	OUTS1545-0002	OUTEXT-0370
	Ag	DMCS1545-0007B	0.5 to 1.82 mm ² (AWG 20 to 15)	STD 0391-0104A3	FT8	TP900-1	OUTS1545-0002	OUTEXT-0370
	Au	DMCS1545-0007-D	0.5 to 1.82 mm ² (AWG 20 to 15)	STD0391-0104A3	FT8	TP900-1	OUTS1545-0002	OUTEXT-0370
	Ag	DMCS1545-0006-B	1.34 to 2.61 mm ² (AWG 15 to 13)	STD 0391-0104A3	FT8	TP900-1	OUTS1545-0002	OUTEXT-0370
	Au	DMCS1545-0006-D	1.34 to 2.61 mm ² (AWG 15 to 13)	STD0391-0104A3	FT8	TP900-1	OUTS1545-0002	OUTEXT-0370
Ø3	Ag	DMCS24578-0003-B	1.34 to 2.61 mm ² (AWG 15 to 13)	DLNS19575-0004	M317	OUTS24823-0003	OUT18990-0004	OUTEXT-0420
	Au	DMCS24578-0003-D	1.34 to 2.61 mm ² (AWG 15 to 13)	DLNS19575-0004	M317	OUTS24823-0003	OUT18990-0004	OUTEXT-0420
	Ag	DMCS19554-0004	2.5 to 4 mm ² (AWG 13 to 11)	DLNS19575-0004	M317	OUTS24823-0003	OUT18990-0004	OUTEXT-0420
	Au	DMCS25036-00A3	2.5 to 4 mm ² (AWG 13 to 11)	DLNS19575-0004	M317	OUTS24823-0003	OUT18990-0004	OUTEXT-0420
	Ag	DMCS24750-0003-B	4 to 6 mm ² (AWG 11 to 9)	DLNS19575-0004	M317	OUTS24823-0003	OUT18990-0004	OUTEXT-0420
Ø3 ^A	Ag	DAMS0692-0130	1.34 to 2.61 mm ² (AWG 15 to 13)	-	M317	TP1065	OUT18990-0004	OUTS1166-0023-0
Ø3 ^B	Ag	DLNS18970-0004	2.07 to 4 mm ² (AWG 14 to 11)	-	MS 3191-1	-	OUT18990-0004	OUTEXT-0420
Ø5	Ag	DLNS1673-205968	4 mm ² (AWG 11)	-	M317	OUTS24823-0003	-	OUTCCIEXT-D0200
	Ag	DLNS24149-00A3	6 mm ² (AWG 9)	-	See T2 page 29	-	-	OUTCCIEXT-D0200
	Ag	DMCS206659-A00	10 mm ² (AWG 7)	-	See T2 page 29	-	-	OUTCCIEXT-D0200
	Ag	DMCS1848-205681	16 mm ² (AWG 5)	-	See T2 page 29	-	-	OUTCCIEXT-D0200
Ø7	Ag	DMCS208558-A00	16 mm ² (AWG 5)	DLNS18968-000M	See T2 page 29	-	-	OUTCCIEXT-G0100
	Ag	DLNS203014	25 mm ² (AWG 3)	DLNS18968-000M	See T2 page 29	-	-	OUTCCIEXT-G0100
	Ag	DMCS206829-A00	35 mm ² (AWG 2)	DLNS18968-000M	See T2 page 29	-	-	OUTCCIEXT-G0100
	Ag	DLNS18972-0004	50 mm ² (AWG 0)	DLNS18968-000M	See T2 page 29	-	-	OUTCCIEXT-G0100
Ø7.9	Ag	DMCS204073-A00	35 mm ² (AWG 2)	-	See T2 page 29	-	-	OUTCCIEXT-H0100
	Ag	DMCS24817-0003	50 mm ² (AWG 0)	-	See T2 page 29	-	-	OUTCCIEXT-H0100
	Ag	DLNS24163-0003	70 mm ² (AWG 00)	-	See T2 page 29	-	-	OUTCCIEXT-H0100
Ø 12	Ag	DMCS1733-201620	35 mm ² (AWG 2)	DMC19947-0004	See T2 page 29	-	-	-
	Ag	DMCS25463-0003	50 mm ² (AWG 0)	DMC19947-0004	See T2 page 29	-	-	-
	Ag	DMCS25461-0003	70 mm ² (AWG 00)	DMC19947-0004	See T2 page 29	-	-	-
	Ag	DMCS25564-0003	95 mm ² (AWG 000)	DMC19947-0004	See T2 page 29	-	-	-

Standard contacts supplied with connector

Ag : Silver plated - Au : Gold plated

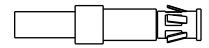

Caliber (mm)		Part Number	Cable section	Obturator	Crimping Tool	Locator	Insertion Tool	Extracting Tool
Ø1.6	Ag	DMCS24151-000B3	0.5 to 1.82 mm ² (AWG 20 to 15)	SRC202730-A00	FT8	TP1012	OUT31748-000A2	OUTEXT 0321
	Au	DLNS24151-0003	0.5 to 1.82 mm ² (AWG 20 to 15)	SRC202730-A00	FT8	TP1012	OUT31748-000A2	OUTEXT 0321
Ø2	Ag	DMCS1545-0009-B	0.22 to 0.93 mm ² (AWG 24 to 18)	STD0391-0104A3	FT8	TP900-1	OUTS1545-0002	OUTEXT-0370
	Au	DMCS1545-0009-D	0.22 to 0.93 mm ² (AWG 24 to 18)	STD0391-0104A3	FT8	TP900-1	OUTS1545-0002	OUTEXT-0370
	Ag	DMCS1545-0005-B	0.5 to 1.82 mm ² (AWG 20 to 15)	STD 0391-0104A3	FT8	TP900-1	OUTS1545-0002	OUTEXT-0370
	Au	DMCS1545-0005-D	0.5 to 1.82 mm ² (AWG 20 to 15)	STD0391-0104A3	FT8	TP900-1	OUTS1545-0002	OUTEXT-0370
	Ag	DMCS1545-0004-B	1.34 to 2.61 mm ² (AWG 15 to 13)	STD 0391-0104A3	FT8	TP900-1	OUTS1545-0002	OUTEXT-0370
	Au	DMCS1545-0004-D	1.34 to 2.61 mm ² (AWG 15 to 13)	STD0391-0104A3	FT8	TP900-1	OUTS1545-0002	OUTEXT-0370
Ø3	Ag	DMCS24577-0003-B	1.34 to 2.61 mm ² (AWG 15 to 13)	DLNS19575-0004	M317	OUTS24823-0003	OUT18990-0004	OUTEXT-0420
	Au	DMCS24577-0003-D	1.34 to 2.61 mm ² (AWG 15 to 13)	DLNS19575-0004	M317	OUTS24823-0003	OUT18990-0004	OUTEXT-0420
	Ag	DMCS19555-0004	2.5 to 4 mm ² (AWG 13 to 11)	DLNS19575-0004	M317	OUTS24823-0003	OUT18990-0004	OUTEXT-0420
	Au	DMCS25037-00A3	2.5 to 4 mm ² (AWG 13 to 11)	DLNS19575-0004	M317	OUTS24823-0003	OUT18990-0004	OUTEXT-0420
	Ag	DMC S24747-0003	4 to 6 mm ² (AWG 11 to 9)	DLNS19575-0004	M317	OUTS24823-0003	OUT18990-0004	OUTEXT-0420
Ø3 ^A	Ag	DMCS1239-0007	1.34 to 2.61 mm ² (AWG 15 to 13)	-	M317	TP1065	OUT18990-0004	OUTEXT0550
Ø3 ^B	Ag	DLNS18971-0004	2.07 to 4 mm ² (AWG 14 to 11)	-	MS 3191-1	-	OUT18990-0004	OUTEXT-0420
Ø5	Ag	DMCS206657-A00	4 to 6 mm ² (AWG 11 to 9)	-	M317	OUTS24823-0003	-	OUTCCIEXT-D0200
	Ag	DMCS24146-00A3	6 mm ² (AWG 9)	-	See T2 page 29	-	-	OUTCCIEXT-D0200
	Ag	DMCS206823-A00	10 mm ² (AWG 7)	-	See T2 page 29	-	-	OUTCCIEXT-D0200
	Ag	DMCS1848-205686	16 mm ² (AWG 5)	-	See T2 page 29	-	-	OUTCCIEXT-D0200
Ø7	Ag	DMCS208559-A00	16 mm ² (AWG 5)	DLNS18968-000F	See T2 page 29	-	-	OUTCCIEXT-G0100
	Ag	DLNS25706-0003	25 mm ² (AWG 3)	DLNS18968-000F	See T2 page 29	-	-	OUTCCIEXT-G0100
	Ag	DLNS18976-0004	35 mm ² (AWG 2)	DLNS18968-000F	See T2 page 29	-	-	OUTCCIEXT-G0100
	Ag	DLNS18973-0004	50 mm ² (AWG 0)	DLNS18968-000F	See T2 page 29	-	-	OUTCCIEXT-G0100
Ø7.9	Ag	DMCS206825-A00	35 mm ² (AWG 2)	-	See T2 page 29	-	-	OUTCCIEXT-H0100
	Ag	DMCS24164-0003	50 mm ² (AWG 0)	-	See T2 page 29	-	-	OUTCCIEXT-H0100
	Ag	DMCS206827-A00	70 mm ² (AWG 00)	-	See T2 page 29	-	-	OUTCCIEXT-H0100
Ø 12	Ag	DMCS201872-A00	35 mm ² (AWG 2)	DMC19948-0004	See T2 page 29	-	-	-
	Ag	DMCS25464-0003	50 mm ² (AWG 0)	DMC19948-0004	See T2 page 29	-	-	-
	Ag	DMCS25462-0003	70 mm ² (AWG 00)	DMC19948-0004	See T2 page 29	-	-	-
	Ag	DMCS25565-0003	95 mm ² (AWG 000)	DMC19948-0004	See T2 page 29	-	-	-

Standard contacts supplied with connector

Ag : Silver plated - Au : Gold plated

RECEPTACLE



32

Square Receptacle



33

Square receptacle with shielding

The panel sealing gasket is supplied with the receptacle

Backshell for RECEPTACLES



EA

Backnut



RD

Environmental Straight Backshell



M

Backshell with ISO thread



PG

Backshell with PG thread

PLUG



36

Plug



38

Plug with shielding

Backshell for PLUGS



RD

Environmental Straight Backshell



M

Backshell with ISO thread



PG

Backshell with PG thread

SHELL TYPES

- 32** Square Receptacle
 - 36** Plug
 - 33** Square Receptacle (shielding)
 - 38** Plug (shielding)
- } except size 02 & 61

BACKSHELL TYPES

- EA** Backnut
- M** Backshell with ISO Thread
- PG** Backshell with PG Thread
NF C 68-315 et DIN 40430
- RD** Environmental straight Backshell

SHELL SIZE

07 - 19 - 27 - 61

CONFIGURATIONS

See pages 16-17

CONTACT TYPES

- P** Male
- S** Female

KEYING SYSTEMS

See the instruction Notice N° FT08010

Sizes 07 - 19 - 27 : N, 1, 2, 3, 4, 5, 6, 7, 8, 9, X, Y

Size 61 : N, 1, 2, 3, 4, 5, 6, 7, 8, 9, A, B, C, D

CABLE INDEXES

See pages 22-23

See accepted cable characteristics

OPTIONS

See pages 18-19

- 090** 96 H Salt Spray : without contact
(to be ordered separately)
- A91** 500 H Salt Spray / Black Varnish : without contacts
(to be ordered separately)

SIZE 07

01

1 contact Ø5^c mm

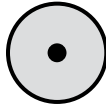

Service Voltage	Withstand Voltage
1500 V	5750 V

* Creepage Dist. : 28 mm - Clearance Dist. : 20 mm

SIZE 19

01

1 contact Ø12^c mm

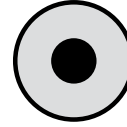

Service Voltage	Withstand Voltage
1500 V	5750 V

* Creepage Dist. : 65 mm - Clearance Dist. : 9.5 mm

04

4 contacts Ø3 mm

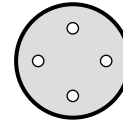

Service Voltage	Withstand Voltage
2000 V	7500 V

* Creepage Dist. : 30 mm - Clearance Dist. : 14 mm

4A

2 contacts Ø6 mm
+ 2 pilotes Ø3^c mm

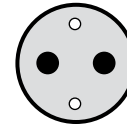

	Service Voltage	Withstand Voltage
NF F 61-030	400 V	3250 V

* Creepage Dist. : 11 mm - Clearance Dist. : 6.5 mm

4C

2 contacts Ø7,9 mm
+ 2 pilotes Ø3^c mm

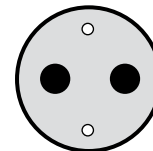

	Service Voltage	Withstand Voltage
NF F 61-030	400 V	3250 V

* Creepage Dist. : 11 mm - Clearance Dist. : 5.5 mm

6B

4 contacts Ø6 mm
+ 2 pilotes Ø3^c mm

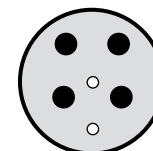

	Service Voltage	Withstand Voltage
NF F 61-030	400 V	3250 V

* Creepage Dist. : 6 mm - Clearance Dist. : 3 mm

XX

Contacts have to be ordered separately. Use code 090 in the part number to indicate this. See pages 18-19.

*Creepage Distance / Clearance Distance (unmated connector)

For the cavities numbering, ask for the data sheet N° FT 08009

SIZE 27

01 1 contact Ø 16 mm

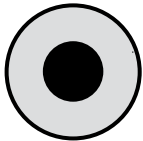

Service Voltage	Withstand Voltage
1500 V	5750 V

* Creepage Dist. : 35 mm - Clearance Dist. : 24 mm

10 10 contact Ø 3 mm

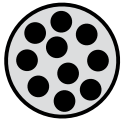

Service Voltage	Withstand Voltage
2000 V	8000 V (mated)

* Creepage Dist. : 30.30 mm (mated) - Clearance Dist. : 31.63 mm (mated)

1A 1 contact Ø 20 mm

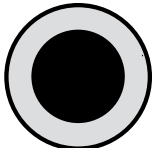

Service Voltage	Withstand Voltage
1500 V	5750 V

* Creepage Dist. : 11 mm - Clearance Dist. : 9 mm

SIZE 61

09 3 contacts Ø12^B mm
6 contacts Ø5^B mm

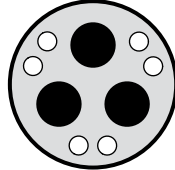

	Service Voltage	Withstand Voltage
NF F 61-030	400 V	3250 V

* Creepage Dist. : 9 mm - Clearance Dist. : 5.85 mm

MAX. DIAMETER OF CONDUCTORS IN THE REAR INSERT

Insert Configuration Arrangement		Ø max. in cavity
07	01	1 x 8 mm
19	01	1 x 24 mm
19	04	4 x 7.7 mm
19	4A	2 x 10.5 mm + 2 x 5 mm
19	4C	2 x 16.3 mm + 2 x 4.5 mm
19	6B	4 x 10.5 mm + 2 x 5 mm
27	01	1 x 36 mm
61	09	3 x 22 mm + 6 x 10 mm

Male Crimp Contacts

CPP

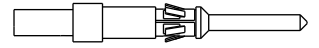

Caliber (mm)	Part Number	Cable section	Obturator	Crimping Tool	Positionner	Extracting Tool	
Ø3	Ag	DMCS24578-0003	1.34 to 2.61 mm ² (AWG 15 to 13)	DLNS19575-0004	M317	OUTS24823-0003	OUTEXT-0420
	Ag	DMCS19554-0004	2.5 to 4 mm ² (AWG 13 to 11)	DLNS19575-0004	M317	OUTS24823-0003	OUTEXT-0420
	Ag	DMCS24750-0003	4 to 6 mm ² (AWG 11 to 9)	DLNS19575-0004	M317	OUTS24823-0003	OUTEXT-0420
Ø3 ^c	Ag	DPPS206345-A00	0.5 to 1.82 mm ² (AWG 20 to 15)	DPP201873-A00	FT8	TP1012	OUTEXT-0420
	Au	DPPS206345-A01	0.5 to 1.82 mm ² (AWG 20 to 15)	DPP201873-A00	FT8	TP1012	OUTEXT-0420
	Ag	DPPS206348-A00	1.34 to 2.61 mm ² (AWG 15 to 13)	DPP201873-A00	M317	OUTS24823-0003	OUTEXT-0420
	Au	DPPS206348-A01	1.34 to 2.61 mm ² (AWG 15 to 13)	DPP201873-A00	M317	OUTS24823-0003	OUTEXT-0420
Ø5 ^b	Ag	DMCS1848-205683	6 mm ² (AWG 9)	-	See Tools / Outils, T2 page 29		OUTCCIEXT-D0200
	Ag	DMCS206659-A00	10 mm ² (AWG 7)	-	See Tools / Outils, T2 page 29		OUTCCIEXT-D0200
	Ag	DMCS1848-205681	16 mm ² (AWG 5)	-	See Tools / Outils, T2 page 29		OUTCCIEXT-D0200
Ø5 ^c	Ag	DPPS205697	10 mm ² (AWG 7)	-	D31	02379	OUTCCIEXT-D0200
Ø6	Ag	DPPS202232-A00	4 mm ² (AWG 11)	DPPS205437-A00	See T2 page 29		OUTCCIEXT-F0100
	Ag	DPPS202146-000	6 mm ² (AWG 9)	DPPS205437-A00	See T2 page 29		OUTCCIEXT-F0100
	Ag	DPPS201799-000	10 mm ² (AWG 7)	DPPS205437-A00	See T2 page 29		OUTCCIEXT-F0100
	Ag	DPPS19627-A004	16 mm ² (AWG 5)	DPPS205437-A00	See T2 page 29		OUTCCIEXT-F0100
	Ag	DPPS23547-00B3	25 mm ² (AWG 3)	DPPS205437-A00	See T2 page 29		OUTCCIEXT-F0100
Ø7.9	Ag	DLNS24163-00A3	70 mm ² (AWG 00)	-	See T2 page 29		OUTCCIEXT-H0100
Ø12 ^b	Ag	DMCS206478	35 mm ² (AWG 2)	-	See T2 page 29		-
	Ag	DPPS203905-A00	50 mm ² (AWG 0)	-	See T2 page 29		-
	Ag	DPPS206927-A00	70 mm ² (AWG 00)	-	See T2 page 29		-
	Ag	DPPS204343-A00	95 mm ² (AWG 000)	-	See T2 page 29		-
	Ag	DMCS1848-205680	120 mm ² (MCM 250)	-	See T2 page 29		-
	Ag	DMCS1848-205679	150 mm ² (MCM 300)	-	See T2 page 29		-
Ø12 ^c	Ag	DPP208460-A00	50 mm ² (AWG 0)	-	See T2 page 29		-
	Ag	DPP208462-A00	95 mm ² (AWG 000)	-	See T2 page 29		-
	Ag	DPP204341-A00	120 mm ² (MCM 250)	-	See T2 page 29		-
Ø16	Ag	DPP201617-A00	120 mm ² (MCM 250)	-	See T2 page 29		-
	Ag	DPP204110-A00	150 mm ² (MCM 300)	-	See T2 page 29		-
	Ag	DPP208528-A00	185 mm ² (MCM 350)	-	See T2 page 29		-

Ag : Silver plated - Au : Gold plated

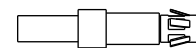

Caliber (mm)	Part Number	Cable section	Obturator	Crimping Tool	Positionner	Extracting Tool
Ø3	Ag DMCS24577-0003	1.34 to 2.61 mm ² (AWG 15 to 13)	DLNS19575-0004	M317	OUTS24823-0003	OUTEXT-0420
	Ag DMCS19555-0004	2.5 to 4 mm ² (AWG 13 to 11)	DLNS19575-0004	M317	OUTS24823-0003	OUTEXT-0420
	Ag DMCS24747-0003	4 to 6 mm ² (AWG 11 to 9)	DLNS19575-0004	M317	OUTS24823-0003	OUTEXT-0420
Ø3 ^c	Ag DPPS206346-A00	0.5 to 1.82 mm ² (AWG 20 to 15)	DPP202176-A00	FT8	TP1012	OUTEXT-0420
	Au DPPS206346-A01	0.5 to 1.82 mm ² (AWG 20 to 15)	DPP202176-A00	FT8	TP1012	OUTEXT-0420
	Ag DPPS206347-A00	1.34 to 2.61 mm ² (AWG 15 to 13)	DPP202176-A00	M317	OUTS24823-0003	OUTEXT-0420
	Au DPPS206347-A01	1.34 to 2.61 mm ² (AWG 15 to 13)	DPP202176-A00	M317	OUTS24823-0003	OUTEXT-0420
Ø5 ^b	Ag DMCS1848-205688	6 mm ² (AWG 9)	-	See T2 page 29		OUTCCIEXT-D0200
	Ag DMCS206823-A00	10 mm ² (AWG 7)	-	See T2 page 29		OUTCCIEXT-D0200
	Ag DMCS1848-205686	16 mm ² (AWG 5)	-	See T2 page 29		OUTCCIEXT-D0200
Ø5 ^c	Ag DPPS205698	10 mm ² (AWG 7)	-	D31	02379	OUTCCIEXT-D0200
Ø6	Ag DPPS202230-A00	4 mm ² (AWG 11)	DPPS205439-A00	See T2 page 29		OUTCCIEXT-F0100
	Ag DPPS202147-A00	6 mm ² (AWG 9)	DPPS205439-A00	See T2 page 29		OUTCCIEXT-F0100
	Ag DPPS201800-000	10 mm ² (AWG 7)	DPPS205439-A00	See T2 page 29		OUTCCIEXT-F0100
	Ag DPPS19628-A004	16 mm ² (AWG 5)	DPPS205439-A00	See T2 page 29		OUTCCIEXT-F0100
	Ag DPPS1731-206665	25 mm ² (AWG 3)	DPPS205439-A00	See T2 page 29		OUTCCIEXT-F0100
Ø7.9	Ag DMCS206827-A00	70 mm ² (AWG 00)	-	See T2 page 29		OUTCCIEXT-H0100
Ø12 ^b	Ag DMCS206477	35 mm ² (AWG 2)	-	See T2 page 29		-
	Ag DPPS203904-A00	50 mm ² (AWG 0)	-	See T2 page 29		-
	Ag DPPS206926-A00	70 mm ² (AWG 00)	-	See T2 page 29		-
	Ag DPPS204344-A00	95 mm ² (AWG 000)	-	See T2 page 29		-
	Ag DMCS1848-205685	120 mm ² (MCM 250)	-	See T2 page 29		-
	Ag DMCS1848-205684	150 mm ² (MCM 300)	-	See T2 page 29		-
Ø12 ^c	Ag DPPS208461-A00	50 mm ² (AWG 0)	-	See T2 page 29		-
	Ag DPPS208463-A00	95 mm ² (AWG 000)	-	See T2 page 29		-
	Ag DPPS204342-A00	120 mm ² (MCM 250)	-	See T2 page 29		-
Ø16	Ag DPPS201619-A00	120 mm ² (MCM 250)	-	See T2 page 29		-
	Ag DPPS204111-A00	150 mm ² (MCM 300)	-	See T2 page 29		-
	Ag DPPS208527-A00	185 mm ² (MCM 350)	-	See T2 page 29		-

Ag : Silver plated - Au : Gold plated

Characteristics & Synoptic

CMB

MATERIALS

Shell : Bronze

Crimp Contacts : Silver or gold plated brass

Insulators : Polyamide

CHARACTERISTICS

Service Temperature : -40°C +120°C

Salt Spray : > 500H

Protection Index : IP67 with environmental straight backshell

MECHANICAL

Mating Cycles : > 500

Fire & Smoke withstand : NF F 16-102 requirement 2



The panel sealing gasket is supplied with the receptacle

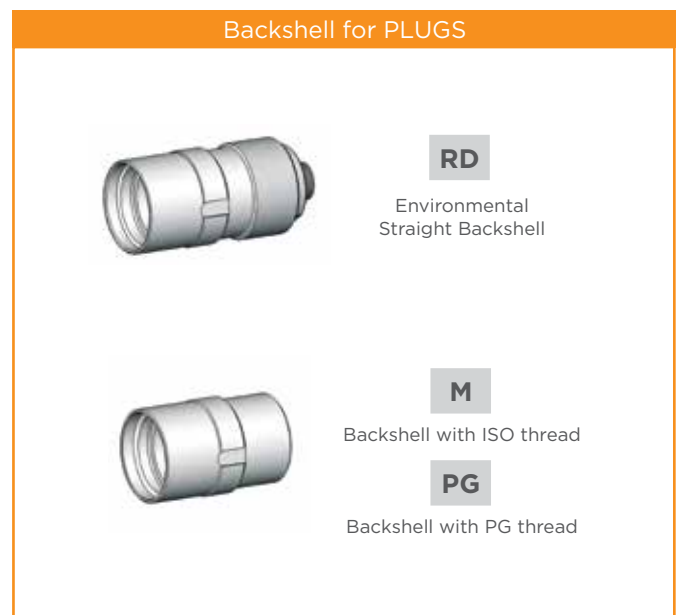
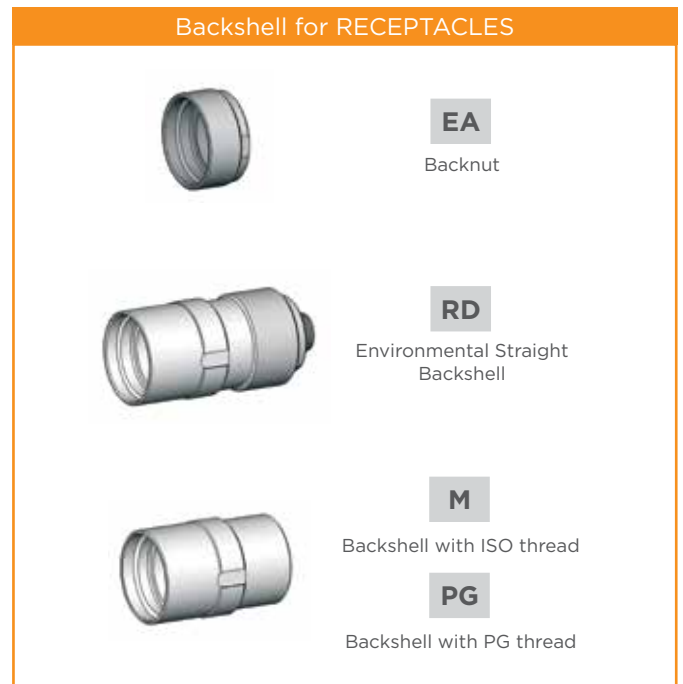

SHELL TYPES

- 32** Square Receptacle
 - 36** Plug
 - 33** Square receptacle (shielding)
 - 38** Plug (shielding)
- } except size 02 & 61

BACKSHELL TYPES

- EA** Backnut
- M** Backshell with ISO thread
- PG** Backshell with PG thread
- RD** Environmental Straight backshell

SHELL SIZE

02 - 04 - 07 - 19 - 27 - 61

CONFIGURATIONS

See pages 10-11 (CMC) & pages 16-17 (CPP)

Defined by the number of cavities in the insert

CONTACT TYPES

- P** Male
- S** Female

KEYING SYSTEMS

See the instruction Notice FT N° 08010

Sizes 02 - 04 - 07 - 19 - 27 : N, 1, 2, 3, 4, 5, 6, 7, 8, 9, X, Y

Size 61 : N, 1, 2, 3, 4, 5, 6, 7, 8, 9, A, B, C, D

CABLE INDEXES

See pages 22-23

See accepted cable characteristics

OPTIONS

- 090** Without contacts
(to be ordered separately)
See pages 12-13 (CMC) & pages 18-19 (CPP)

Backshells : Cable Indexes

CMC/ CPP/CMB

BACKSHELLS WITH ISO THREAD

M	Shell Size					
	02	04	07	19	27	61
M12 x 1.5	C					
M16 x 1.5	D	D				
M20 x 1.5	E	E				
M25 x 1.5		G	G			
M32 x 1.5			H	H		
M40 x 1.5				K	K	
M50 x 1.5				L	L	L
M63 x 1.5					M	M



Receptacle & Plug with Backshell for Metric Outlet

BACKSHELLS WITH PG THREAD (NF C 68-312 / DIN 40430)

PG	Shell Sizes					
	02	04	07	19	27	61
9	D	D				
11	E	E				
13	F					
16		G	G			
21			H		H	
29				K	K	
36				L	L	
42					M	
48 DIN					N	N
48 NFC					P	P



Receptacle & Plug with Backshell for PG Outlet

Backshells : Cable Indexes

CMC/PP/CMB

ENVIRONMENTAL STRAIGHT BACKSHELLS

CABLE INSULATION O.D. Ø ext.		Shell Sizes					
Min.	Max.	02	04	07	19	27	61
5.5 (0.216)	8 (0.315)		D	D			
7.5 (0.295)	10 (0.394)	E	E	E			
9.5 (0.374)	11.5 (0.453)			F			
12 (0.472)	14 (0.551)		H	H			
13.5 (0.531)	17 (0.669)			L	L		
16 (0.630)	21 (0.827)			M			
16.5 (0.649)	20 (0.787)				N		
19.5 (0.768)	23.5 (0.925)				P	P	
22 (0.866)	28 (0.102)				Q	Q	
31 (1.220)	33 (1.299)				T	T	
32 (1.259)	36 (1.417)					W	W
36 (1.417)	40 (1.574)					X	X
42 (1.653)	46 (1.811)						Z
44 (1.732)	48 (1.890)						Y

mm / (inch)



RD

Plug and Receptacle with environmental straight backshell



● Cover for receptacle with chain (sizes 27/61) or string (sizes 02/04/07/19)



● Cover for plug with chain (sizes 27/61) or string (sizes 02/04/07/19)



● Dummy Receptacle



30°



45°

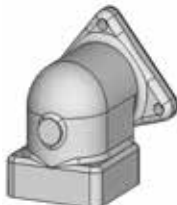

90°

● Angled Support



● Hood for Receptacle (Dust protection)

Accessories

CMC/CP

No standard accessories for the CMB series

96 HOURS SALT SPRAY

Accessories	Shell Sizes					
	02	04	07	19	27	61
Cover for receptacle (Aluminium)	CMCBE02	CMCBE04	CMCBE07	CMCBE19	CMCBE27	DMCS1590-1000-0
Cover for receptacle (Polyamide)	CMCBE02-150	CMCBE04-254	CMCBE07-256	CMCBE19-112	CMCBE27-019	DMCS1590-4000-0
Cover for plug (Aluminium)	CMCBF02	CMCBF04	CMCBF07	CMCBF19	CMCBF27	DMCS1590-2000-0
Cover for plug (Polyamide)	CMCBF02-219	CMCBF04-255	CMCBF07-257	CMCBF19-113	CMCBF27-020	DMCS1590-3000-0
Dummy Socket	CMCBR02	CMCBR04	CMCBR07	CMCBR19	CMCBR27	CMCBR61
30° angled support				CMCPT30-19		CMCPT30-61
45° angled support		CMCPT45-04				CMCPT45-61
90° angled support			CMCPT90-07	CMCPT90-19	CMCPT90-27	CMCPT90-61
Hood (santoprene)		CMCT04	CMCT07	CMCT19	CMCT27	CMCT61

500 HOURS SALT SPRAY

Accessories	Shell Sizes					
	02	04	07	19	27	61
Cover for receptacle (Aluminium)	CMCBE02A01	CMCBE04A01	CMCBE07A01	CMCBE19A01	CMCBE27A01	CMCBE61A01
Cover for receptacle (Polyamide)	CMCBE02-150	CMCBE04-254	CMCBE07-256	CMCBE19-112	CMCBE27-019	DMCS1590-4000-0
Cover for plug (Aluminium)	CMCBF02A01	CMCBF04A01	CMCBF07A01	CMCBF19A01	CMCBF27A01	CMCBF61A01
Cover for plug (Polyamide)	CMCBF02-219	CMCBF04-255	CMCBF07-257	CMCBF19-113	CMCBF27-020	DMCS1590-3000-0
Dummy Socket	CMCBR02A01	CMCBR04A01	CMCBR07A01	CMCBR19A01	CMCBR27A01	CMCBR61A01
30° angled support				CMCPT30-19A01		CMCPT30-61A01
45° angled support		CMCPT45-04A01				CMCPT45-61A01
90° angled support			CMCPT90-07A01	CMCPT90-19A01	CMCPT90-27A01	CMCPT90-61A01
Hood (santoprene)		CMCT04	CMCT07	CMCT19	CMCT27	CMCT61

PLUG

With environmental straight backshell **RD**

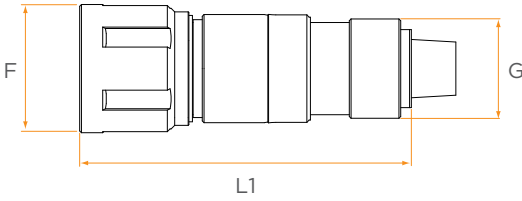

Size	02	04	07	19	27	61
F	28 (1.10)	36 (1.42)	45 (1.77)	63 (2.48)	81 (3.19)	106 (4.17)
G	28 (1.10)	32 (1.26)	39 (1.53)	56 (2.20)	74 (2.91)	80 (3.15)
L1	116 (4.57)	106 (4.17)	118 (4.64)	118 (4.64)	151 (5.94)	331 (13.03)
L2	69 (2.78)	78 (3.07)	95 (3.74)	95 (3.74)	107 (4.21)	173 (6.81)

mm / (inches)

With backshell for PG & ISO outlet **PG / M**

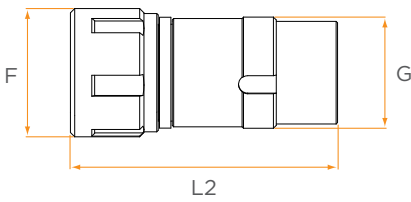

SQUARE FLANGE RECEPTACLE

With environmental straight backshell **EA**

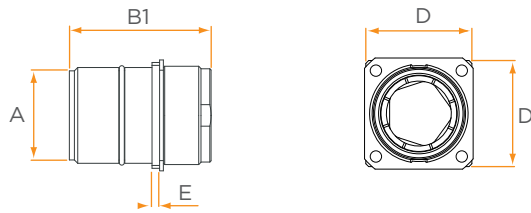

Size	02	04	07	19	27	61
A	24 (0.94)	32 (1.26)	37,9 (1.49)	56 (2.20)	74 (2.91)	96 (3.78)
B1 (EA)	44 (1.73)	46 (1.81)	48,7 (1.92)	48,7 (1.92)	56,4 (2.22)	85 (3.34)
B2 (PG)	72 (2.83)	78 (3.07)	95 (3.74)	101 (3.98)	102,5 (4.03)	180 (7.09)
B3 (RD)	118 (4.64)	106 (4.17)	120 (4.72)	123 (4.84)	152 (5.98)	265 (10.43)
C	31 (1.22)	35 (1.38)	36 (1.42)	36 (1.42)	36 (1.42)	56 (2.20)
D	25 (0.98)	35 (1.38)	42 (1.65)	67 (2.64)	79 (3.11)	112 (4.41)
E	3 (0.12)	3 (0.12)	3 (0.12)	3 (0.12)	5 (0.20)	9 (0.35)

mm / (inches)

With backshell for PG & ISO outlet **PG / M**

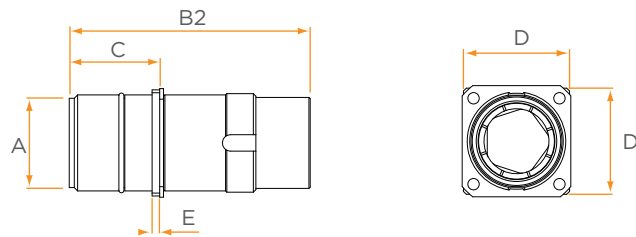

With environmental straight backshell **RD**

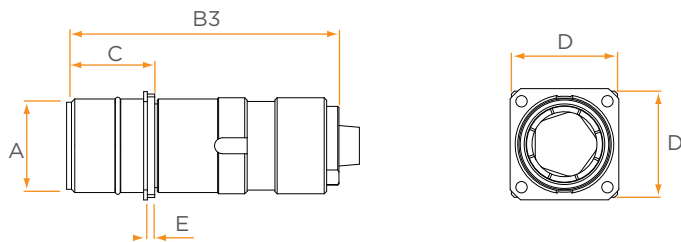

MATED CONNECTORS

With Environmental Straight Backshell **RD**

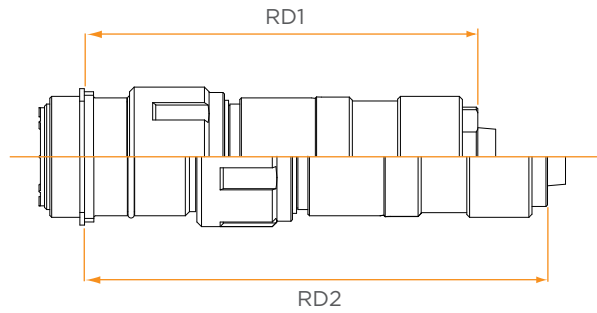

Size	02	04	07	19	27	61
RD1 Mated	126 (4.96)	117 (4.60)	133 (5.24)	133 (5.24)	165 (6.50)	354 (13.94)
RD2 Unmated	147 (5.79)	139 (5.47)	154 (6.06)	154 (6.06)	189 (7.44)	387 (15.24)

mm max. / (inches)

With Backshell for PG & ISO Outlet **PG - M**

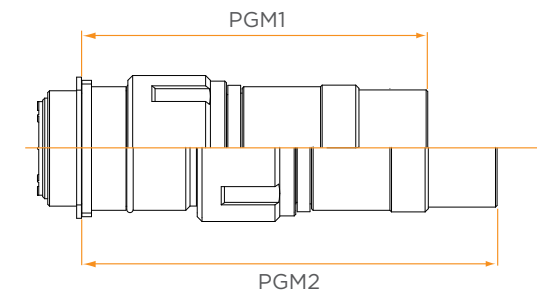

Size	02	04	07	19	27	61
PGM1 Mated	78 (3.07)	89 (3.50)	108,5 (4.27)	108,5 (4.27)	123 (4.84)	193 (7.06)
PGM2 Unmated	100 (3.94)	111 (4.37)	131 (5.16)	131 (5.16)	145 (5.70)	229 (9.02)

mm max. / (inches)

COUPLING TORQUE

Size	Backnut ①	Coupling Barrel ②	Backshell ③
02	10 Nm	10 Nm	10 Nm
04	10 Nm	15 Nm	10 Nm
07	15 Nm	25 Nm	20 Nm
19	25 Nm	40 Nm	25 Nm
27	45 Nm	68 Nm	45 Nm
61	50 Nm	90 Nm	50 Nm

Note : Indicate values (CMC)



Panel Cut Out & Weights

CMC/ CPP/CMB

RECEPTACLE & DUMMY SOCKET

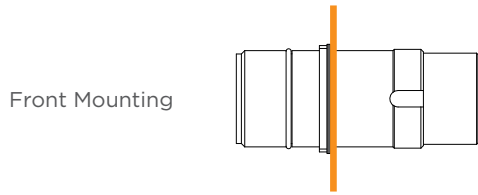

Front Mounting

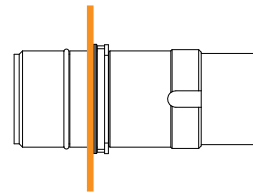

Rear Mounting

Size	02	04	07*	19*	27	61
A	27 (1.06)	27 (1.06)	34* (1.34)	52* (2.04)	64 (2.52)	88 (3.46)
B	29 (0.14)	32 (1.26)	40* (1.57)	57* (2.24)	75 (2.95)	96 (3.78)
C	3.5 (0.14)	3.5 (0.14)	4.5* (0.18)	4.5* (0.18)	7 (0.27)	9.5 (0.37)

* Back mounting possible

mm / (inches)

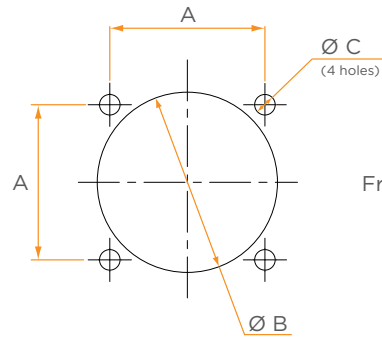

Front & Rear Mounting

ANGLED SUPPORT

Size	02	04	07	19	19	61	61
		45°	90°	30°	90°	30° & 45°	90°
D	-	55 (2.16)	38.5 (1.52)	70 (2.75)	88 (3.46)	138 (5.43)	113 (3.46)
E	-	3.5 (0.14)	4.4 (0.17)	4.5 (0.18)	10 (0.39)	9.5 (3.74)	9 (3.78)
F	-	27 (1.06)	50 (1.97)	54 (2.12)	62.5 (2.46)	98 (3.86)	98 (3.86)
G	-	30.5 (1.20)	28.5 (1.12)	56.5 (2.22)	59 (2.32)	92 (3.62)	92 (3.62)

mm / (inches)

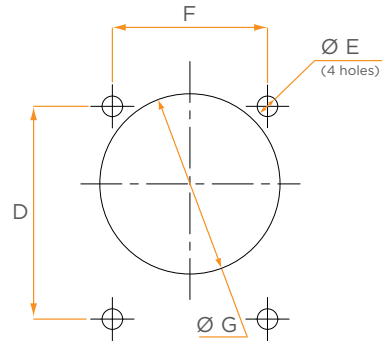

Front Mounting

APPROXIMATE WEIGHTS without contact - Version CMC : Alu

Description			02	04	07	19	27	61
Image	32EA	Square Receptacle with backnut	35	70	85	190	355	810
Image	32M & 32PG	Square Receptacle with ISO or PG thread backshell	70	90	110	285	520	1775
Image	32RD	Square Receptacle with environmental straight backshell	80	135	135	240	415	1805
Image	36M & 36PG	Plug with ISO or PG thread backshell	110	80	140	295	575	2000
Image	36RD	Plug with environmental straight backshell	120	150	205	250	470	2030

(g)

MECHANICAL MANUAL PLIERS

Tools	Part Numbers	Part Numbers
Pliers AMP	49935	OUT0405-0223AS
Pliers COJACK	MS3191-1	OUT0405-0102AS
Pliers DMC	FT8	OUT0405-0167AS
Positionner DMC	TP1012	OUT0405-0176AS
Positionner DMC	TP900-1	OUT0405-0168AS
Pliers / Pince DMC	M317	OUT0405-0110AS
Positionner DMC	TP1065	OUT0405-0218AS
Pliers DUBUIS	D31	OUT0405-0117AS
Die DUBUIS	O2379	OUT0405-0142AS





T1



DMC Plier

HEXAGONAL TOOLS - MECATRACTION

T2

Cable Section	Manual Pliers		Hydraulic Pliers 13 Tonnes		Hydraulic Pliers 20 Tonnes	
	Pliers	Die	Pliers	Die	Pliers	Die
4 mm ²		D5HCU4-120 OUT0405-0371AS				
6 mm ²		H1 35-6 OUT0405-0187AS				
10 mm ²		H1 10-35F OUT0405-0199AS				
16 mm ²		H1 16-50F OUT0405-0137AS				
25 mm ²	PMM1 OUT0405-0314AS	H1 25-70F OUT0405-0138AS		TN25V13 OUT0405-0419AS		TN25V20 OUT0405-454AS
35 mm ²		H1 10-35F OUT0405-0199AS	PA133K OUT0405-0367AS	TN35V13 OUT0405-0420AS	PA133K OUT0405-0367AS	TN35V20 OUT0405-0455AS
50 mm ²		H1 16-50F OUT0405-0137AS		TN50V13 OUT0405-0413AS		TN50V20 OUT0405-0421AS
70 mm ²		H1 25-70F OUT0405-0138AS		TN70V13 OUT0405-0422AS		TN70V20 OUT0405-0380AS
95 mm ²			F 4622 K OUT0405-0360AS	TN95V13 OUT0405-0423AS	F 4622 K OUT0405-0360AS	TN95V20 OUT0405-0424AS
120 mm ²				TN120V13 OUT0405-0412AS		TN120V20 OUT0405-0425AS
150 mm ²			SU 130K OUT0405-0441AS	TN150V13 OUT0405-0445AS	SU 210K OUT0405-0443AS	TN150V20 OUT0405-0426AS
185 mm ²					Adapter S21 (for SU 210K) OUT0405-0389AS	TN185V20 OUT0405-0397AS

Die for manual pliers



Die 13 TONNES



Die 20 TONNES



FOR MORE INFORMATION

Follow us on Twitter for all the latest product news @TEConnectivity, and on Facebook, TEConnectivity.

TECHNICAL SUPPORT

te.com/support-center

North America.....	+1 800 522 6752
Asia Pacific	+86 0 400 820 6015
Austria	+43 1 905 601 228
Baltic Regions.....	+46 8 5072 5000
Benelux	+31 73 6246 999
Czech Republic	+420 800 701 462
France.....	+33 1 34 20 86 86
Germany	+49 6251 133 1999
Hungary	+36 809 874 04
Italy.....	+39 011 401 2632
Nordic.....	+46 8 5072 5000
Poland.....	+48 800 702 309
Russia.....	+7495 790 790 2
Spain/Portugal.....	+34 93 2910366
Switzerland.....	+41 52 633 66 26
United Kingdom	+44 800 267 666

te.com

TE Connectivity, TE Connectivity (logo) and Every Connection Counts are trademarks. All other logos, products and/or company names referred to herein might be trademarks of their respective owners.

While TE has made every reasonable effort to ensure the accuracy of the information in this brochure, TE does not guarantee that it is error-free, nor does TE make any other representation, warranty or guarantee that the information is accurate, correct, reliable or current. TE reserves the right to make any adjustments to the information contained herein at any time without notice. TE expressly disclaims all implied warranties regarding the information contained herein, including, but not limited to, any implied warranties of merchantability or fitness for a particular purpose. The dimensions in this catalog are for reference purposes only and are subject to change without notice. Specifications are subject to change without notice. Consult TE for the latest dimensions and design specifications.

© 2017 TE Connectivity Ltd. family of companies All Rights Reserved.

1-1773921-8 08/17 Original

CATALOG

Tyco Electronics UK Ltd.

Faraday Road,
Dorcan,
Swindon,
Wiltshire,
SN3 5HH

Tel 01793 528171
www.te.com